



PASSION FOR INNOVATION



WINTER 2023/24



PASSION FOR INNOVATION

WINTER 2023/24



NORDIC POLES

PRO RACING _____	7
RACING _____	10
ADVANCED _____	12
AMATEUR _____	13
KIDS _____	14

SKI TOURING / TELEMARCK

RACING _____	18
ADVANCED _____	19
TELESCOPE _____	20

ACCESSORIES

HANDLES _____	23
STRAPS _____	24
DISKS & TIPS _____	26
QCD SYSTEM _____	27
BAGS _____	28
EQUIPMENT _____	34
BOOTS _____	36
BINDINGS _____	37

EYEWEAR

39

APPAREL

TECHNICAL _____	46
FREE TIME _____	60
JACKETS _____	62
KIDS _____	68
UNDERWEAR _____	71
GLOVES _____	75
HATS _____	81

SHAFTS FEATURES

TORNADO PLUS / BORA

- 100% carbon
- Dynamic graphics
- Stiffer carbon
- Proportional stiffness calculation: longer poles are now as stiff as shorter ones
- Diameter at the top 16.5 mm and at the bottom 8.5 mm
- Python Twist Tech: the bottom part is reinforced with additional carbon bands that increase shaft stiffness and provide shock resistance to the pole
- Optimally balanced for light swing

TORNADO BLUE & PINK / ELITE

- 100% carbon
- Dynamic graphics
- Stiffer carbon
- Proportional stiffness calculation: longer poles are now as stiff as shorter ones
- Diameter at the top 16.5 mm and at the bottom 8.5 mm
- Optimally balanced for light swing

TORNADO PLUS JUNIOR

- Colour similar to TORNADO PLUS
- 80% carbon
- Diameter at the top 16.5 mm and at the bottom 10 mm
- The adequate balance point allows good pending movement
- Very stable

TORNADO JUNIOR

- Colour similar to TORNADO
- 30% carbon
- Diameter at the top 16.5 mm and at the bottom 10 mm
- Good stability

FUTURE

- Nice colours for kids
- 10% carbon
- Diameter at the top 16.5 mm and at the bottom 10 mm

TEMPESTA

- Available in 2 different colours
- 100% carbon
- Diameter at the top 16.5 mm and at the bottom 10 mm
- The balance point allows good pending movement
- Very stable

VIKING

- White and black colour easy to combine with all ski colours
- 70% carbon
- Diameter at the top 16.5 mm and at the bottom 10 mm
- Very stable

ADVANCE

- 50% carbon
- Diameter at the top 16.5 mm and at the bottom 10 mm
- Good stability

CAMPRA

- Available in 2 different colours
- 30% carbon, from 150 cm 40% carbon
- Diameter at the top 16.5 mm and at the bottom 10 mm
- Good stability

SIMANO / QUEBEC

- Nice soft colours
- SIMANO 30% carbon
- QUEBEC Aluminium Ergal 7075
- Top diameter SIMANO 16.5 mm / QUEBEC 16 mm
- Bottom diameter 10 mm

STRAP SIZES

Strap size	Lenght of poles	
	ELITE CLIP	EVOLUTION CLIP
XS	—	80 – 120
S	130 -142.5	122.5 – 142.5
M/L	145 -172.5	145 – 170
XL	175 – 185	172.5 – 185

Measures in cm

SHAFTS



PTT Python Twist Tech: the bottom part is reinforced with additional carbon bands that increase shaft stiffness and provide shock resistance to the pole.



Super Light Best carbon compound to give maximum lightness and stiffness.



UNPAINTED: The lower part of the stick is not painted, which makes the stick more solid and greener (reduced use of paint).



STIFFNESS: We measure here the stiffness/flexibility of the stick. The 80cm length of the lower part of the tube is stressed until it is bent by 15mm. The resistance is measured in kg and corresponds to the weight of the thrust. The results were divided into 3 categories, namely:

- 1 = superior** (from 17 kg to 21 kg)
- 2 = good** (11 kg to 14 kg)
- 3 = medium** (7 kg to 10 kg)



SWING: A good balance of the pole leads to a better momentum of the movement. The balance of the stick is measured in cm starting from the centre of gravity of the tube and calculating the difference between the lower and upper parts. The results were divided into 3 categories namely:

- 1 = superior** (from 13cm to 16cm)
- 2 = good** (6cm to 10cm)
- 3 = medium** (2cm to 5cm)

PROTECTION



Rubber cover for tip protection during transport.

HANDLES



- Automatic closing system
- Easy to use
- Clip System
- Thermo-cork
- Top to strap 4.8cm



- Easy to use
- Clip system
- Thermo-cork
- Longer shape
- Best strap & handle connect.
- Lightweight
- Top-strap distance 4 cm



- Easy to use
- Thermo-cork
- Longer shape
- Best strap-handle connection
- Top to strap 4 cm



- Easy to use
- Clip system
- Thermo-cork
- Longer shape
- Best strap-handle connection
- Top to strap 4 cm



- Easy to use
- Clip system
- Thermo-cork
- Longer shape
- Top to strap 4.5 cm



- Easy to use
- Thermo-cork
- Longer shape
- Top-strap distance 4 cm



- Easy to use
- Thermo-cork
- Longer shape
- Top-strap distance 4 cm

STRAPS



- Ergonomic design
- Available in 3 different sizes
- Resistant fabric
- Double ribbon around the palm for better pole control
- Buckle adjustable in 4 positions



- Ergonomic design
- Available in 4 different sizes
- Resistant fabric
- Double ribbon around the palm for better pole control



- Ergonomic design
- Available in 2 sizes
- Resistant fabric
- Right and left
- Special shape for thumb support



- Ergonomic design
- Available in 3 different sizes
- Resistant fabric
- Double ribbon around the palm for better pole control
- Buckle adjustable in 4 positions



- Ergonomic design
- Available in 3 different sizes
- Resistant fabric
- Double ribbon around the palm for better pole control
- Buckle adjustable in 4 positions



- Ergonomic design
- Available in 4 different sizes
- Resistant fabric
- Double ribbon around the palm for better pole control



- Available in 2 sizes
- Resistant fabric
- For beginners or rent

DISKS & TIPS



- ø 8.5 and 9.5 mm
- Original design
- Quickly removable disk
- Compatible with qcd winter system
- Available trekking/rollerski tip



- ø 8.5 or 9.5 mm
- Super light
- Well-visible on snow
- Best shape for the impact on the snow and for force transmission
- Special plastic: cold and impact resistant
- Suitable for all types of snow



- ø 8.5 mm
- Super light
- Visible on the snow
- Best shape for the impact on the snow and for force transmission
- Special plastic: cold and impact resistant



- Titanium tip
- Extra light
- Resistant



- Swinging disk for fresh snow
- Original design
- Quickly removable disk
- Compatible with qcd winter system
- ø 8.5 and 9.5 mm



- ø 9.5 mm
- Super light
- Best shape for the impact on the snow and for force transmission
- Special plastic: cold and impact resistant



- ø 9.5 mm
- Super light
- Best shape for the impact on the snow and for force transmission
- Special plastic: cold and impact resistant



TORNADO LIGHT CARBON TITAN

24P001Q

Material: 100% carbon;
62 g/m (+/- 2 g/m)
Length: 130-185 cm
Steps of 2.5 cm

Shaft: 23P414
Handle: 7P103.17 (ø 16.5 mm)
Strap: 23P200
Insert & Nut: 8P302 (ø 8.5 mm)
Tip: 20P331; 20P318

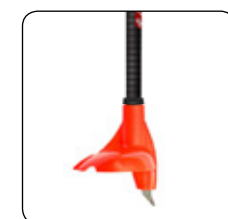
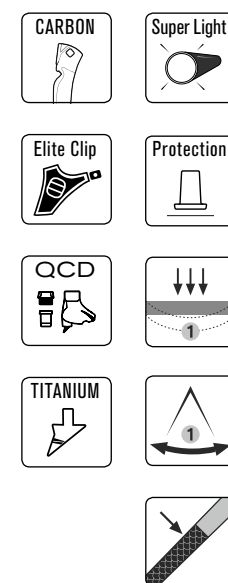

TORNADO PLUS TITAN

23P002Q

WITH TITAN TIPS

23P003Q

WITH STEEL TIPS

Material: 100% carbon;
66 g/m (+/- 3 g/m)
Length: 130-185 cm
Steps of 2.5 cm

Shaft: 23P400
Handle: 22P104.17 (ø 16.5 mm)
Strap: 23P200
Insert & Nut: 8P302 (ø 8.5 mm)
Tip for 23P002Q: 20P331; 7P325
Tip for 23P003Q: 20P324

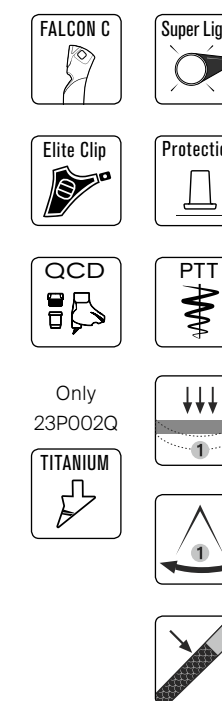

Only
23P002Q

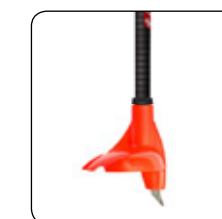

TORNADO BLUE

24P004Q

Material: 100% carbon;
66 g/m (+/- 3 g/m)
Length: 130-185 cm
Steps of 2.5 cm

Shaft: 23P401
Handle: 22P104.17 (ø 16.5 mm)
Strap: 23P200
Insert & Nut: 8P302 (ø 8.5 mm)
Tip: 20P324



TORNADO PINK

23P004QP

Material: 100% carbon; 66 g/m
Length: 130-180 cm
Steps of 2.5 cm

Shaft: 23P400P
Handle: 22P104.17 (ø 16.5 mm)
Strap: 23P200.P
Insert & Nut: 8P302 (ø 8.5 mm)
Tip: 20P324.P



BORA

22P005Q

Material: 100% carbon;
71 g/m (+/- 3 g/m)
Length: 130-185 cm
Steps of 2.5 cm

Shaft: 22P402
Handle: 22P104.17 (ø 16.5 mm)
Strap: 23P200
Insert & Nut: 8P302 (ø 8.5 mm)
Tip: 20P324

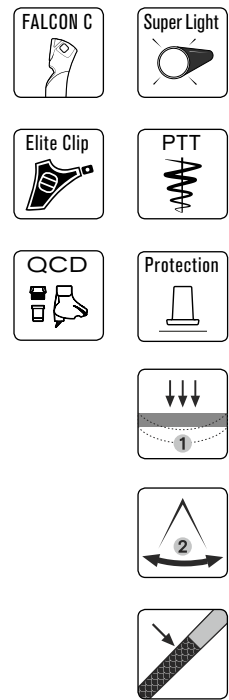

ELITE

23P015Q

Material: 100% carbon;
73 g/m (+/- 3 g/m)
Length: 130-185 cm
Steps of 2.5 cm

Shaft: 23P403
Handle: 22P104.17 (ø 16.5 mm)
Strap: 23P200
Insert & Nut: 8P302 (ø 8.5 mm)
Tip: 20P324.G

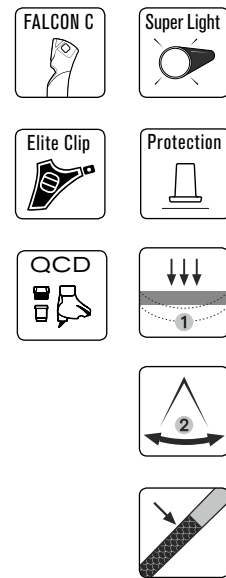

TEMPESTA

Material:
100% carbon – 76 g/m
Length: 130-185 cm
Steps of 2.5 cm



23P006

Shaft: 23P404
Handle: 3P100.OR (ø 16.5 mm)
Strap: 9P202
Tip: 4P301.OR (ø 10 mm)



23P006Q

Shaft: 23P404
Handle: 3P100.OR (ø 16.5 mm)
Strap: 9P202
Insert & Nut: 8P323 (ø 10 mm)
Tip: 7P325



TEMPESTA BLUE

Material:
100% carbon – 76 g/m
Length: 130-185 cm
Steps of 2.5 cm



23P007

Shaft: 23P404B
Handle: 3P100.OR (ø 16.5 mm)
Strap: 9P202
Tip: 4P301.OR (ø 10 mm)



23P007Q

Shaft: 23P404B
Handle: 3P100.OR (ø 16.5 mm)
Strap: 9P202
Insert & Nut: 8P323 (ø 10 mm)
Tip: 7P325



VIKING

23P008

Material: 70% carbon – 80 g/m
Length: 125-185 cm
Steps of 2.5 cm

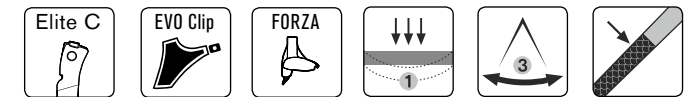

Shaft: 22P404
Handle: 3P100.17 (ø 16.5 mm)
Strap: 9P202
Tip: 3P301 (ø 10 mm)

ADVANCE

23P009

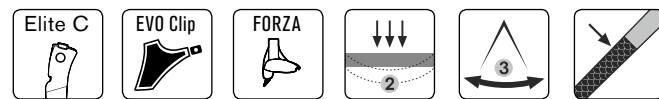
**Material:**

50% carbon – 80 g/m

Length: 110-175 cm

Steps of 2.5 cm

Shaft: 23P406**Handle:** 3P100.17 (ø 16.5 mm)**Strap:** 9P202**Tip:** 3P301 (ø 10 mm)

CAMPRA

23P010

**Material:**

30% carbon for 120–150 cm – 86 g/m

40% carbon for 150–170 cm – 84 g/m

Length: 120-170 cm

Steps of 2.5 cm

Shaft: 23P407**Handle:** 3P100.17 (ø 16.5 mm)**Strap:** 9P202**Tip:** 3P301 (ø 10 mm)

CAMPRA PINK

23P010P

**Material:**

30% carbon for 120–150 cm – 86 g/m

40% carbon for 150–170 cm – 84 g/m

Length: 120-170 cm

Steps of 2.5 cm

Shaft: 23P407P**Handle:** 3P100.17.P (ø 16.5 mm)**Strap:** 9P202**Tip:** 20P301.P (ø 10 mm)

SIMANO C

22P012

**Material:** 30% carbon – 89 g/m**Length:** 125-170 cm

Steps of 5 cm

Shaft: 21P415**Handle:** 3P100.17 (ø 16.5 mm)**Strap:** 9P202**Tip:** 3P301 (ø 10 mm)

SIMANO

21P014

**Material:** 30% carbon – 89 g/m**Length:** 125-170 cm

Steps of 5 cm

Shaft: 21P415**Handle:** 21P107.17 (ø 16.5 mm)**Strap:** 21P208**Tip:** 21P332 (ø 10 mm)

QUEBEC C

22P013

**Material:** Aluminium Ergal 7075**Length:** 110-170 cm

Steps of 5 cm

Shaft: 22P409**Handle:** 3P100.16 (ø 16 mm)**Strap:** 9P202**Tip:** 3P301 (ø 10 mm)

QUEBEC

22P019

**Material:** Aluminium Ergal 7075**Length:** 110-170 cm

Steps of 5 cm

Shaft: 22P409**Handle:** 7P101.16 (ø 16 mm)**Strap:** 7P205**Tip:** 3P301 (ø 10 mm)

TORNADO PLUS JUNIOR

Material: 80% carbon – 73 g/m

Length: 110-160 cm

Steps of 2.5 cm



23P003J

Shaft: 23P410

Handle: 3P100.OR (ø 16.5 mm)

Strap: 9P202

Tip: 4P301.OR (ø 10 mm)



23P003JQ

Shaft: 23P410

Handle: 3P100.OR (ø 16.5 mm)

Strap: 9P202

Insert & Nut: 8P323 (ø 10 mm)

Tip: 7P325



TORNADO PLUS JUNIOR PINK

23P003JQP

Material: 80% carbon – 73 g/m

Length: 110-160 cm

Steps of 2.5 cm

Shaft: 23P410P

Handle: 3P100.17.P (ø 16.5 mm)

Strap: 9P202

Insert & Nut: 8P323 (ø 10 mm)

Tip: 8P325.P



TORNADO JUNIOR

23P010J

Material: 30% carbon – 84 g/m

Length: 90-150 cm

Steps of 2.5 cm

Shaft: 23P411

Handle: 3P100.OR (ø 16.5 mm)

Strap: 9P202

Tip: 4P301.OR (ø 10 mm)



TORNADO JUNIOR PINK

23P010JP

Material: 30% carbon – 84 g/m

Length: 90-150 cm

Steps of 2.5 cm

Shaft: 23P411P

Handle: 3P100.17.P (ø 16.5 mm)

Strap: 9P202

Tip: 20P301.P (ø 10 mm)



FUTURE

21P019J

Material: 10% carbon

Length: 70-140 cm

Steps of 5 cm

Shaft: 21P416

Handle: 21P107.17 (ø 16 mm)

Strap: 7P205

Tip: 21P332 (ø 10 mm)



SKI TOURING

TELEMARK

KVH

WINTER

2023/24

KVH

AMÉLIE WENGER-REYMOND

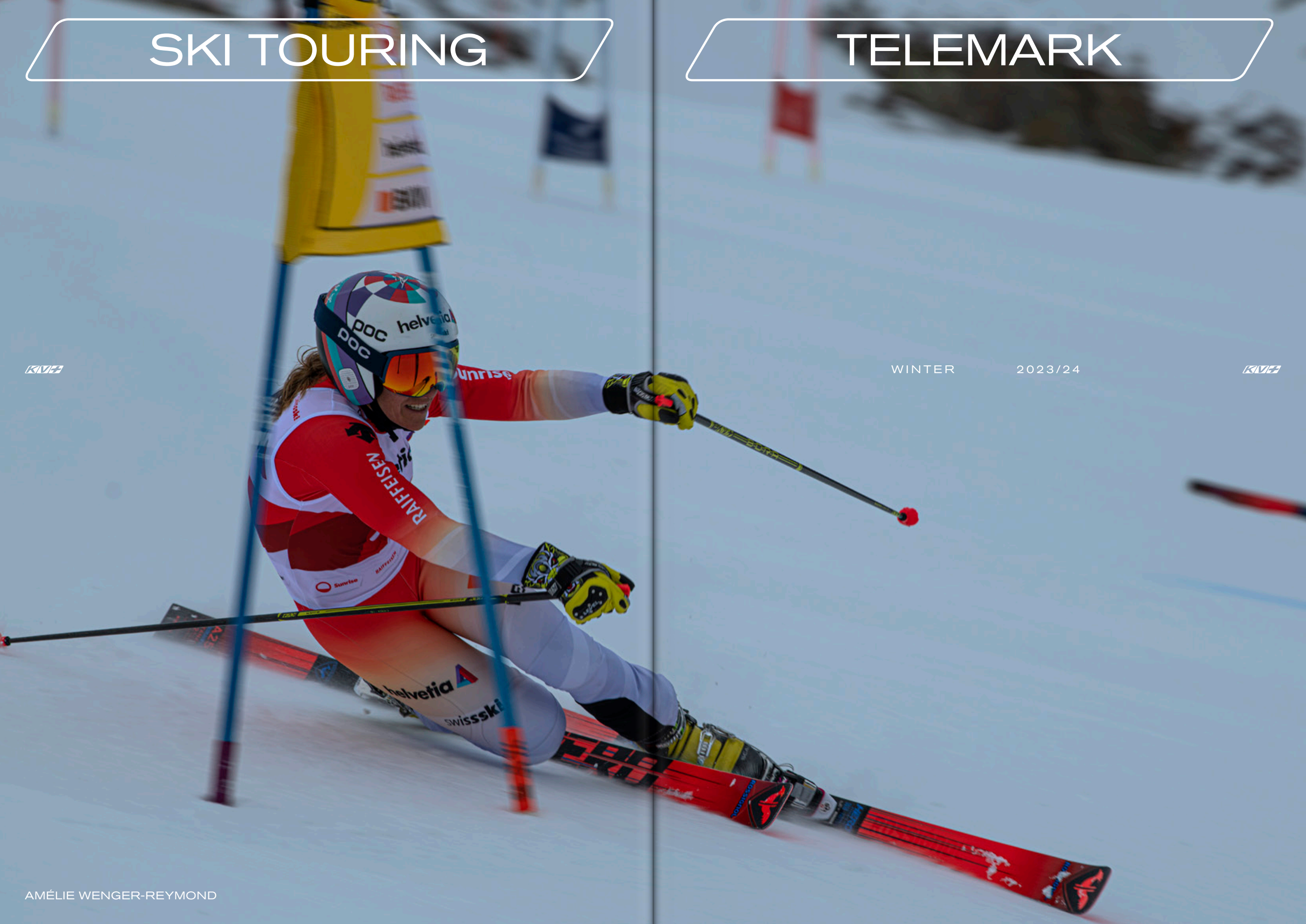

BORA ST

22P011Q

Material: 100% carbon - 62 g/m
Length: 120-145 cm
 Steps of 2.5 cm

Shaft: 22P402
Handle: 7P101.17 (ø 16.5 mm)
Strap: 6P210
Insert & Nut: 8P302 (ø 8.5 mm)
Tip: 9P329



QUEBEC ST

22P019Q

Material: Aluminium Ergal 7075
Length: 110-155 cm
 Steps of 5 cm

Shaft: 22P409
Handle: 7P101.16 (ø 16 mm)
Strap: 7P205
Insert & Nut: 8P323 (ø 10 mm)
Tip: 22P333



VENTO ST

23P024Q

2 SECTIONS
 TELESCOPE POLE
 (ø 16.5 / 14 mm)

Material: 100% carbon top,
 30% carbon bottom
Length: 115-145 cm

Insert & Nut: 8P323 (ø 10 mm)
Tip: 22P333



AURÉLIEN GAY

CERVINO

23W16



4 SECTIONS FOLDING POLE (ø 18 / 16 / 14 / 10 mm)
CLAMP LOCK SYSTEM

Material: 80% carbon
Length: 110-135 cm
Transport length: 46 cm
Weight: 210 g

Insert & Nut: 8P323 (ø 10 mm)
Tip: 9P331
Rubber Tip: 20P316



AROSA

9W15U

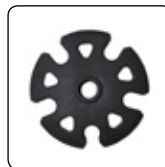

3 SECTIONS TELESCOPE POLE (ø 16.5 / 14 / 10 mm)
CLAMP LOCK SYSTEM

Material: 80% carbon
Length: 100-135 cm
Transport length: 61 cm
Weight: 193 g

Disk 1: 2P312
Disk 2: 2P311
Tip: 2P319 (ø 10 mm)
Rubber Tip: 2P316



AROSA QCD

9W15UQ



3 SECTIONS TELESCOPE POLE (ø 16.5 / 14 / 10 mm)
CLAMP LOCK SYSTEM

Material: 80% carbon
Length: 100-135 cm
Transport length: 61 cm
Weight: 195 g

Insert & Nut: 8P323 (ø 10 mm)
Tip: 9P331
Rubber Tip: 20P316



TRINITY QCD

23W14Q

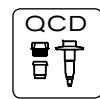

3 SECTIONS TELESCOPE POLE (ø 16.5 / 14 / 10 mm)
CLAMP LOCK SYSTEM

Material: 90% carbon
Length: 100-135 cm
Transport length: 62 cm
Weight: 186 g

Insert & Nut: 8P323 (ø 10 mm)
Tip: 9P331
Rubber Tip: 20P316



AURORA

8W18



3 SECTIONS TELESCOPE POLE (ø 18 / 16 / 14 mm)
CLAMP LOCK SYSTEM

Material: Aluminium 70-75
Length: 90-135 cm
Transport length: 61 cm
Weight: 268 g

Disk: 2P311
Tip: 2P319 (ø 10 mm)
Rubber Tip: 2P316



AURORA QCD

9W18Q



3 SECTIONS TELESCOPE POLE (ø 18 / 16 / 14 mm)
CLAMP LOCK SYSTEM

Material: Aluminium 70-75
Length: 90-135 cm
Transport length: 61 cm
Weight: 268 g

Insert & Nut: 8P323 (ø 10 mm)
Tip: 9P331
Rubber Tip: 20P316



ACCESSORIES



FAST CLIP

23P114.16

Ø 16 mm - 1 pair

23P114.17

Ø 16.5 mm - 1 pair

Weight: 28 g



CARBON CLIP

7P103.17

Ø 16.5 mm - 1 pair

Weight: 19 g



FALCON CLIP

22P104.16

Ø 16 mm - 1 pair

22P104.17

Ø 16.5 mm - 1 pair

22P104.17.B

Ø 16.5 mm - 6 pairs

Weight: 26.5 g



ELITE CLIP

3P100.16

Ø 16 mm - 1 pair

3P100.17

Ø 16.5 mm - 1 pair

3P100.17.B

Ø 16.5 mm - 6 pairs

Weight: 29 g



ELITE CLIP OR

3P100.OR

Ø 16.5 mm - 1 pair

3P100.OR.B

Ø 16.5 mm - 6 pairs

Weight: 29 g



ELITE CLIP PINK

3P100.17.P

Ø 16.5 mm - 1 pair

Weight: 29 g



FALCON

21P109.17

Ø 16.5 mm - 1 pair

Weight: 26 g



ELITE

7P101.16

Ø 16 mm - 1 pair

7P101.17

Ø 16.5 mm - 1 pair

7P101.17.B

Ø 16.5 mm - 6 pairs

Weight: 29 g



RACE 3

21P107.17

Ø 16.5 mm - 1 pair

Weight: 34 g



BAND FOR ELITE CLIP

21P113

1 pair

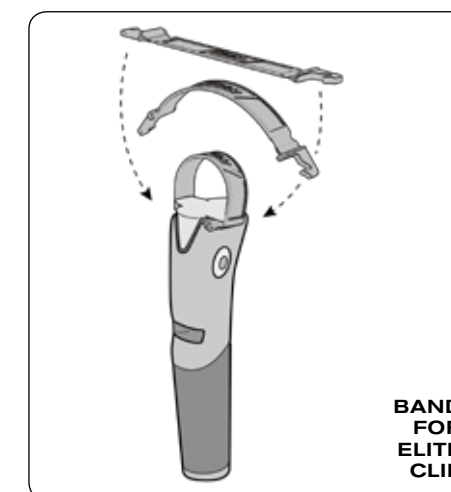

BAND FOR ELITE CLIP

**LOCK SYSTEM
FALCON CLIP**

22P106

1 pair

**LOCK SYSTEM
FALCON**

21P112

1 pair

**LOCK SYSTEM
FAST CLIP**

23P115

1 pair

**ADAPTER
FOR LENGTH**

9P111

1 pair

**WEDGES
FOR ELITE**

7P110

1 pair

**WEDGES
FOR RACE 3**

21P110

1 pair

**BIATHLON**

6P210

Size: S, M/L
1 pair**BIATHLON 2**

21P211

Size: M/L
1 pair**BIATHLON 3**

23P212

Size: S, M/L, XL
1 pair**RENTAL**

7P205

Size: S, M/L
1 pair**UNIVERSAL CLIP**

6P204

One Size
1 pair**ELITE CLIP**

23P200

Size: S, M/L, XL
1 pair**ELITE CLIP PINK**

23P200P

Size: S, M/L
1 pair**ELITE**

23P201

Size: S, M/L, XL
1 pair**FALCON**

23P207

Size: S, M/L, XL
1 pair**EVOLUTION CLIP**

9P202

Size: XS, S, M/L, XL
1 pair**EVOLUTION**

9P203

Size: XS, S, M/L, XL
1 pair**EVO 3**

21P208

Size: S, M/L, XL
1 pair

ELITE

3P300

Ø 8.5 mm - 1 pair

3P300.B

Ø 8.5 mm - 6 pairs



ELITE OR

3P300.OR

Ø 8.5 mm - 1 pair

3P300.OR.B

Ø 8.5 mm - 6 pairs

20P300.OR

TITAN - Ø 8.5 mm - 1 pair



FORZA

3P301

Ø 10 mm - 1 pair

3P301.B

Ø 10 mm - 6 pairs



FORZA OR

4P305.OR

Ø 8.5 mm - 1 pair

4P301.OR

Ø 10 mm - 1 pair

4P305.OR.B

Ø 8.5 mm - 6 pairs

4P301.OR.B

Ø 10 mm - 6 pairs



FORZA PINK

20P301.P

Ø 10 mm - 1 pair



BLIZZARD

7P308

Ø 10 mm - 1 pair



BLIZZARD OR

7P308.OR

Ø 8.5 mm - 1 pair



FIOCCO

21P332

Ø 10 mm - 1 pair



VID TIP ROLLERSKI

7P303

Ø 8,5 mm - 1 pair

7P303.B

Ø 8,5 mm - 6 pairs



VID TIP ROLLERSKI EXTRA

7P304

Ø 10 mm - 1 pair

7P304.B

Ø 10 mm - 6 pairs



RUBBER PROTECTION TIP

21P317

1 pair



VID TIP TRACK

2P319

Ø 10 mm - 1 pair



DISK WINTER

2P312

for: 2P319
Ø 95 mm

TORNADO TIP ROLLERSKI

7P326

1 pair



SNOW TOUR DISK

22P333

1 pair



TIP TREKKING QCD

9P331

1 pair



TORNADO DISK

7P325

BIG - 1 pair



TORNADO DISK GREY

8P325.G

BIG - 1 pair



TORNADO DISK PINK

8P325.P

BIG - 1 pair



20P324

SMALL - 1 pair



20P324.G

SMALL - 1 pair



20P324.P

SMALL - 1 pair



20P331

SMALL TITAN - 1 pair

DISK XS TITAN

20P318

1 pair



DISK XL

9P329

1 pair



QUICK CHANGE DISK & TIP COMPLETE SET

8P327

Ø 8.5 mm - 3 pairs

8P328

Ø 9.5 mm - 3 pairs



KEY FOR QCD

Help for opening/closing QCD nuts

9P330

1 piece



BASE INSERT & NUT FOR SHAFTS

8P302

Ø 8.5 mm - 1 pair

8P323

Ø 9.5 mm - 1 pair



SKI BAG

23D08

Up to 3 pairs of skis
Fabric: 100 % Polyester
Length: 208 cm
Height: 24 cm
Depth: 13 cm

**BIG SKI BAG**

23D09

Length: 200 cm

23D21

Length: 210 cm

Up to 6 pairs of skis
Fabric: 100 % Polyester

**POLE BAG**

23D03

Up to 3 pairs of poles
Fabric: 100 % Polyester
Length: 180 cm
Height: 14 cm
Depth: 14 cm

**RIGID POLE BAG**

22D10

Up to 5 pairs of poles
Fabric: 100 % Polyester
Length: 150-195 cm
 adjustable
Ø: 15 cm

**SMALL RIGID POLE BAG**

22D19

Up to 2 pairs of poles
Fabric: 100 % Polyester
Length: 150-195 cm
 adjustable
Ø: 10 cm

**ROLLERSKI BAG**

22D17

Up to 4 pairs of rollerskis
Fabric: 100 % Polyester
Length: 84 cm
Height: 16 cm
Depth: 19 cm



RUCKSACK 35L

24D14.12

Fabric: 100 % Polyester
Dimensions: 52x32x23 cm
Volume: 35 L
Weight: 0.9 kg
 Straps for compression



RUCKSACK 45L

24D22.12

Fabric: 100 % Polyester
Dimensions: 59x48x38 cm
Volume: 45 L
Weight: 1.3 kg
 Straps for compression
 Protective cover



RUCKSACK 30L

24D15.12

Fabric: 100 % Polyester
Dimensions: 58x34x21 cm
Volume: 30 L
Weight: 0.9 kg
 Straps for compression



TROLLEY CASE

20D13.12

Fabric: 100 % Polyester
Dimensions: 54x32x23 cm
Volume: 40 L
Weight: 3.0 kg
 Straps for compression
 Optional rucksack



EASY BAG

21D31

Fabric: 100 % Polyester
Dimensions: 75x55 cm



TRANSFORMER BAG

6D28.12

Fabric: 100 % Polyester
Dimensions: 24x17x5 cm



PIONEER BACKPACK

23D29

Backpack
 without water bladder
Volume: 5 L



JURA TRAINING VEST

8D30

Training vest
 included water bladder 2 litres

WAIST BAG
WITH THERMO BOTTLE

23D07



WAIST BAG

23D07A



THERMO BOTTLE

5D07B

Volume: 500 ml



THERMO COVER

7D23

For Jura water bladder



SOFT FLASK

8D04B

Volume: 326 ml





KV+

ACCESSORIES

WINTER 2023/24

THERMO WAIST BAG EXTRA

22D26

Volume: 1 litre



THERMO WAIST BAG WITH LED

22D32

Volume: 1 litre



THERMO WAIST BAG

22D05

Volume: 1 litre



THERMO WAIST BAG REFLEX

23D34

Volume: 1 litre



GASKET FOR COVER WAIST BAG

24D35

Gasket for:
22D26, 22D05, 22D32, 23D34



SKI CLIP

1 piece



PROTECTION FILM FOR SHAFTS

1 pair

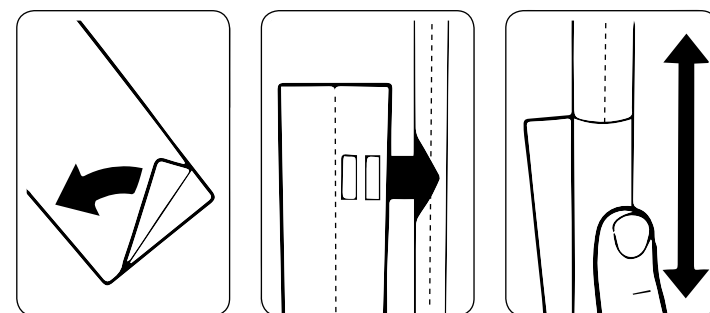

1. Clean pole's surface using alcohol or other degreaser.
2. Peel the film off from underlay.
3. Align film's central line with pole's shaft centre.
4. For maximum protection, place the film as close as possible to the pole's end.
5. Press the film down with your finger along central line.
6. Keep pushing it down and smoothing it out from centre to sides, avoiding air bubbles.

**PROTECTION FILM
APPLICATION & USE RECOMMENDATIONS**

POLES HOLDER

For 1 pair of poles

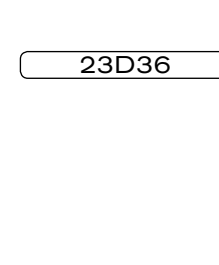

TOOL FOR SHAFTS CUTTING

22D33

Special clamp designed to cut 2 shafts at the same time, saving the carbon fibre structure and the topcoat.

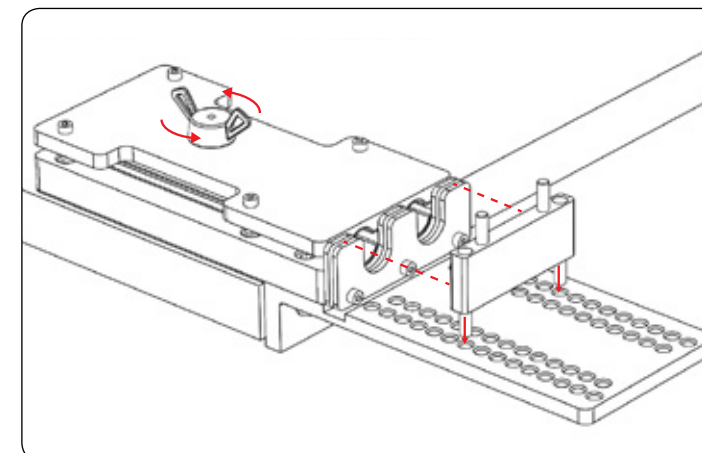

1. Place the cutting tool on stable plane (a standard clamp can also be used on side in the appropriate space)
2. Unscrew the central knob (without remove it)
3. Position the end-stop according to the desired cutting size (the interval between the holes is of 5mm)

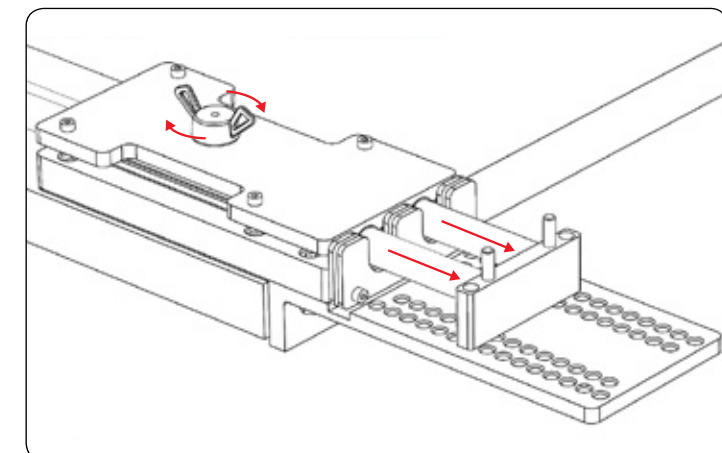

4. Insert the shafts right up against the end-stop
5. Screw the central knob to lock the shafts
6. Remove the end-stop

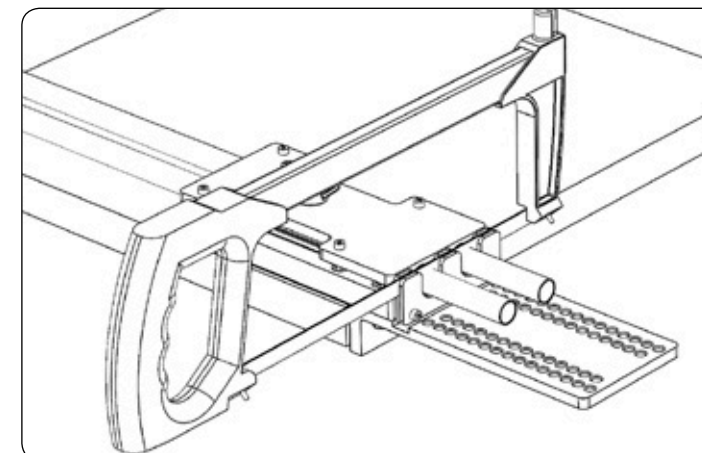

7. Cut with an appropriate saw (if you need you can adjust the distance between guides)

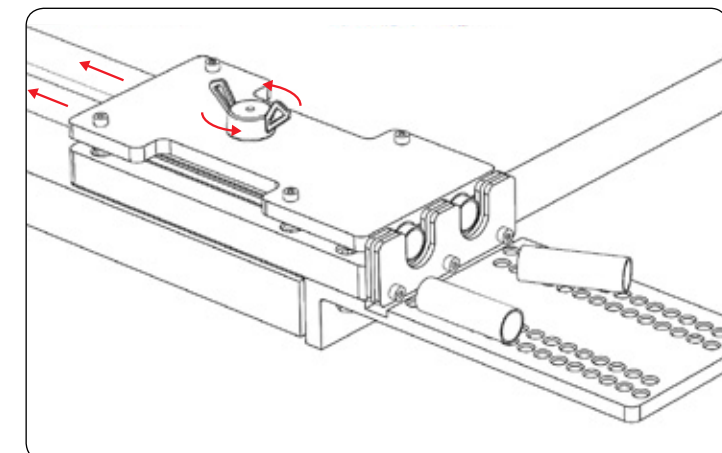

8. Unscrew the central knob to remove the shafts.
9. Enjoy your shafts with perfect length.

TORNADO SKATE

Colour: Black / Grey ; Blue / Red
Size: 35–48
Sole: XCELERATOR SKATE
Features: Race last, elite cuff, plastic heel counter with carbon stabilizer gaiter built-in elastic insert 45° lacing system, tx-loop lacing, anatomic footbed, stiff flex.



24BT01.2

TORNADO CLASSIC

Colour: Black / Grey ; Blue / Red
Size: 35–48
Sole: XCELERATOR CLASSIC
Features: Race last, plastic heel counter gaiter, 90° lacing system tx-loop lacing anatomic footbed soft flex



24BT02.2



24BT01.1



24BT02.1

CH5 SKATE

Colour: Black / Grey / Blue
Size: 35–48
Sole: T4
Features: Plastic for heel counter adjustment



22BT03

CH5 CLASSIC

Colour: Black / Grey / Blue
Size: 35–48
Sole: NNN



22BT04

KV+ PROLINK PRO CLASSIC

L4167270001



KV+ PROLINK PRO SKATE

L4167260001



KV+PROLINK ACCESS CLASSIC

L4049930001



KV+ PROLINK ACCESS SKATE

L4049920001



KV+ PROLINK ACCESS JR CLASSIC

L4049940001



KV+ PROLINK RACE JR SKATE

L4049950001



EYEWEAR



TICINO

SG14.1

Frame: Black, Grey (Grilamid TR90)
Provided with: microfiber bag



LENSES	UV 400 PROTECTION	POLY-CARBONATE	POLARIZED	ANTI-FOG	VENT LENS	VISIBLE LIGHT TRANSMISSION
CW36 RED IR.	•	•		•		CAT 3

SG14.5

Frame: Orange, Red (Grilamid TR90)
Provided with: microfiber bag



LENSES	UV 400 PROTECTION	POLY-CARBONATE	POLARIZED	ANTI-FOG	VENT LENS	VISIBLE LIGHT TRANSMISSION
CW36 RED REVO	•	•	•	•		CAT 3

SG14.7

Frame: Grey, Lime, Black (Grilamid TR90)
Provided with: microfiber bag



LENSES	UV 400 PROTECTION	POLY-CARBONATE	POLARIZED	ANTI-FOG	VENT LENS	VISIBLE LIGHT TRANSMISSION
CW31 YELLOW REVO	•	•				CAT 3



VERTICAL

SG13.1

Frame: Black (Grilamid TR90)
Adjustable nose pads
Provided with: microfiber bag



LENSES	UV 400 PROTECTION	POLY-CARBONATE	POLARIZED	ANTI-FOG	VENT LENS	VISIBLE LIGHT TRANSMISSION
CW36 SKY RED REVO	•	•				CAT 3

SG13.2

Frame: Blue (Grilamid TR90)
Adjustable nose pads
Provided with: second spare lens + microfiber bag + window box



LENSES	UV 400 PROTECTION	POLY-CARBONATE	POLARIZED	ANTI-FOG	VENT LENS	VISIBLE LIGHT TRANSMISSION
CW56 SKY BLUE REVO	•	•	•	•		CAT 3
CW36 RED REVO	•	•		•		CAT 0



DELTA

SG12.2

Frame: Blue (Grilamid TR90)
Provided with: microfiber bag + window box



LENSES	UV 400 PROTECTION	POLY-CARBONATE	POLARIZED	ANTI-FOG	VENT LENS	VISIBLE LIGHT TRANSMISSION
CW56 SKY BLUE	•	•	•	•	•	CAT 3

SG12.91

Frame: Black Transparent (Grilamid TR90)
Provided with: microfiber bag + window box



LENSES	UV 400 PROTECTION	POLY-CARBONATE	POLARIZED	ANTI-FOG	VENT LENS	VISIBLE LIGHT TRANSMISSION
CW56 SKY BLUE	•	•	•	•	•	CAT 3

SG12.9

Frame: Black Transparent (Grilamid TR90)
Provided with: microfiber bag + window box



LENSES	UV 400 PROTECTION	POLY-CARBONATE	POLARIZED	ANTI-FOG	VENT LENS	VISIBLE LIGHT TRANSMISSION
CW56 PHOTOCROMIC	•	•		•	•	CAT 3



APPAREL



KVZ

WINTER 2023/24



KVZ



STRETCH FABRIC – A classic double opposite interlace warp knitted fabric weighting 190 g/m²-80/20, produced using multifilament super dull polyester yarns and elastomer.



(EN) Bonded tape seam - (DE) Geklebttes Nahtband - (FR) Ruban de couture adhesif collé - (IT) Cucitura incollata - (RU) Клееный шов



SUPER ROUBAIX – The remarkable perspiration, burst, elasticity, comfort features combined with the soft and swollen handfeel of the brushing the unquestionable resistance also to strong uses and the easy maintenance, make it a real and undisputed reference point in the stretch brushed fabrics. Fabric suggested both far competitive uses and active-wear, outdoor, leisure and fashion clothing.



(EN) Flat-lock seam - (DE) Flache Naht - (FR) Couture plate - (IT) Cucitura piatta - (RU) Клееный шов

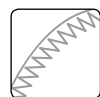

(EN) Overlock seam - (DE) Overlock Naht - (FR) Couture overlock - (IT) Cucitura overlock - (RU) Шов «оверлок»



WIND PROTECT – Maximum protection from wind and good water repellency. Suitable for cold climates. Naturally repellent does not mean completely waterproof.



(EN) Stitching seam - (DE) Doppelnadelstich - (FR) Couture double aiguille - (IT) Impuntura - (RU) Двойной шов



WATER REPELLENT – A term applied to fabrics that have been treated with a finish which causes them to shed water, but are still air-permeable.



(EN) Reflex tape- (DE) Reflektierender Tape- (FR) Bande réfléchissante- (IT) Nastro rifrangente - (RU) Светоотражающая полоска



WATER- WIND PROTECT – A term applied to fabrics whose pores have been closed and therefore will not allow water or air to pass through them



(EN) Reflex zipper - (DE) Reflektierender Reissverschluss - (FR) Zip réfléchissant - (IT) Cerniera rifrangente - (RU) Светоотражающая молния



SEAMLESS – Seamless yarn is the first high-performance specifically designed for use with seamless technology. Softly joined like a second skin to offer seamless garments in the best performance in terms of comfort, fit, freedom of movement, ease of cleaning and a good dimensional stability.

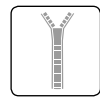

(EN) Open end zipper- (DE) Open-end Reissverschluss- (FR) Zip ouvrable - (IT) Cerniera arabile - (RU) Разъемная молния

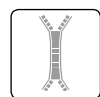

(EN) 2- way separating zipper - (DE) Zweiweg-Reissverschluss - (FR) Zip à 2 glissières séparées - (IT) Cerniera a 2 cursori separati - (RU) Двухсторонняя разъемная молния



ANTIBACTERIA – This fabric has been studied to obtain maximum hygienic protection, with antimicrobial and antibacterial action. The effective active-defense against a large spectrum of micro-organism such as bacteria, fungus and moulds, guarantees freshness and hygiene for the body, preventing bad odors and many allergic effects.



(EN) Inside facing- (DE) Abdeckung innere Deckschicht - (FR) Couche protectrice interne - (IT) Paramontura interna - (RU) Закрытая застёжка



(EN) Adjustable waist - (DE) Verstellbarer bund - (FR) Taille réglable - (IT) Vita regolabile - (RU) Регулировщик шнурка на талии

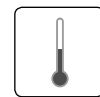

THERMO PROTECTION – Thermo protection fabric allows the perfect regulation of body's temperature.



(EN) One pocket - (DE) Eine Tasche - (FR) Une poche - (IT) Una tasca - (RU) Один карман



(EN) Praformed knee - (DE) Vorgeformte Knie - (FR) Genou préformé - (IT) Ginocchio preformato - (RU) Анатомический покррой колена



(EN) Multi pockets - (DE) Mehrere Taschen - (FR) Poches multiples - (IT) Più tasche - (RU) Несколько карманов



(EN) Removable braces - (DE) Abnehmbare Hosenträger - (FR) Bretelles amovibles - (IT) Bretelle removibili - (RU) Отстегивающийся лямки



(EN) Removable hood - (DE) Abnehmbare kapuze - (FR) Capuchon amovible - (IT) Cappuccio removibile - (RU) Отстегивающийся капюшон



(EN) Close fitting - (DE) Atletische Passform- (FR) Coupe moulante - (IT) Linea attillata - (RU) Облегающий крой

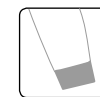

(EN) Elastic cuff - (DE) Elastisches Bündel - (FR) Manchette élastique - (IT) Polsino elastico - (RU) Эластичный манжет



(EN) Loose fitting - (DE) Locker geschnittene Passform - (FR) Coupe ample - (IT) Linea ampia - (RU) Свободный крой



(EN) Silicon elastic gripper - (DE) Elastisches Silicon-Gripband - (FR) Bande élastique en silicone - (IT) Elastico con silicone - (RU) Силиконовая лента



(EN) Padded jacket - (DE) Gefütterte Jacke (FR) Veste matelassée - (IT) Giubbotto imbottito - (RU) Мягкая куртка

REFERENCE SIZES

		XS	S	M	L	XL	XXL	3XL
Man	Height		165–170	170–175	175–180	180–185	185–190	190–195
	Chest		89–94	94–99	99–104	105–109	109–114	114–119
	Waist		70–75	75–80	80–85	85–90	90–95	95–100
Woman	Height	155–160	160–165	165–170	170–175	175–180		
	Chest	75–80	80–90	90–95	95–100	100–105		
	Waist	65–70	70–75	75–80	80–85	85–90		
Unisex	Height	160–165	165–170	170–175	175–180	180–185	185–190	190–195
	Chest	78–85	85–92	92–99	99–104	105–109	109–114	114–119
	Waist	65–70	70–75	75–80	80–85	85–90	90–95	95–100

COLOUR CODES

0	1	2	3	4	5	6	7	8	9	11	12	13	14	21
White	Black	Blue	Red	Navy	Orange	Bordeaux	Green	Petrol	Grey	Anthraccite	Pink	Yellow	Lilac	Turquoise

TORNADO TWO PIECES SUIT UNISEX

Fabric: 82% Polyester, 18% Spandex
Size: XS, S, M, L, XL, XXL, 3XL



24V118.21

Black / Turquoise

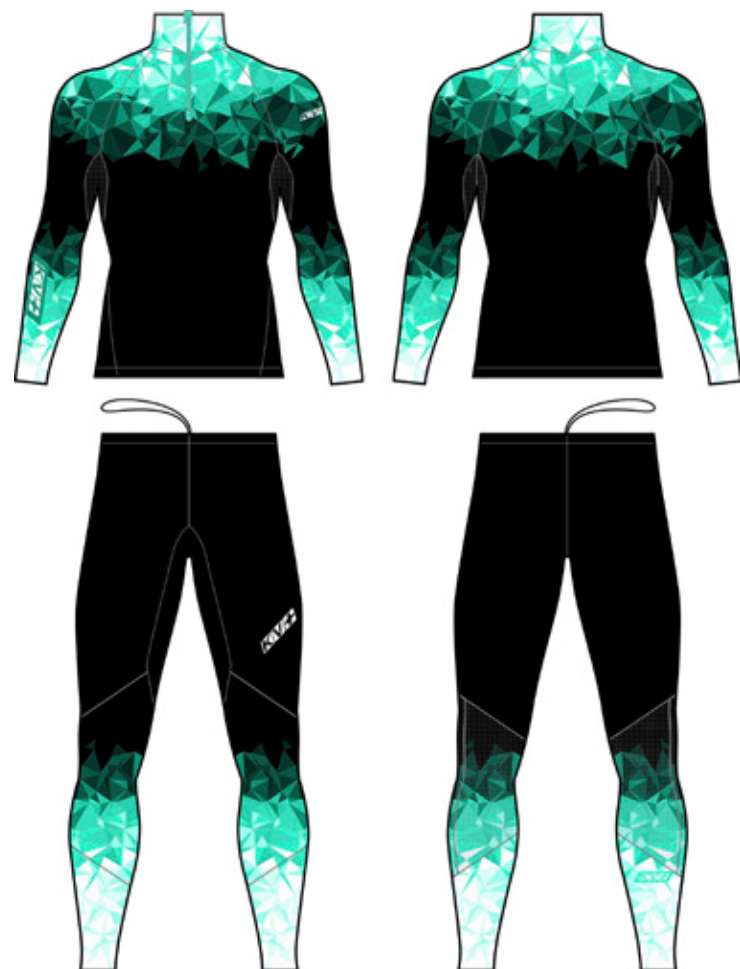

23V118.3

Black / Red / White

23V118.20

Blue / White



**TORNADO JACKET
MAN**

Fabric: 92% Polyester, 8% Spandex
Size: S, M, L, XL, XXL, 3XL



24V104.21

Black / Turquoise



24V104.3

Black / Red



24V104.4

Dark Blue



22V104.12

Black / Blue



22V104.7

Black / Olive Green

**TORNADO JACKET
WOMAN**

Fabric: 92% Polyester, 8% Spandex
Size: XS, S, M, L, XL



24V107.21

Black / Turquoise



24V107.14

Black / Lilac



24V107.4

Dark Blue



22V107.12

White / Pink



24V107.04

White / Lilac

**TORNADO VEST
MAN**

Fabric: 92% Polyester, 8% Spandex
Size: S, M, L, XL, XXL, 3XL



24V102.21

Black / Turquoise



22V102.12

Black / Blue

**TORNADO
PANTS
MAN**

Fabric: 92% Polyester, 8% Spandex
Size: S, M, L, XL, XXL, 3XL

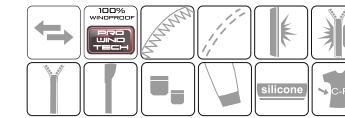

22V105.1

Black



24V105.4

Dark Blue



**TORNADO
SHORTS
MAN**

Fabric: 60% Polyester,
33% Polyurethane, 7% Spandex
Size: S, M, L, XL, XXL, 3XL

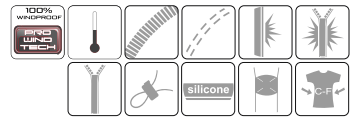

23V123.1

Black



TORNADO VEST
WOMAN

Fabric: 92% Polyester, 8% Spandex
Size: XS, S, M, L, XL



24V103.21
Black / Turquoise



24V103.14
Black / Lilac



TORNADO PANTS
WOMAN

Fabric: 92% Polyester, 8% Spandex
Size: XS, S, M, L, XL

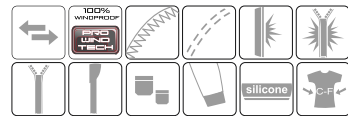

22V108.1
Black



24V108.4
Dark Blue



TORNADO SHORTS
WOMAN

Fabric: 60% Polyester, 33% Polyurethane, 7% Spandex
Size: XS, S, M, L, XL

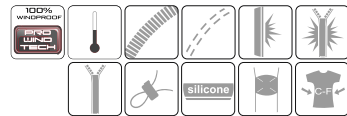

23V124.1
Black



PREMIUM JACKET
UNISEX

Pro-wind-tech fabric: 50% Polyester,
35% Nylon, 15% Spandex
Size: XS, S, M, L, XL, XXL, 3XL

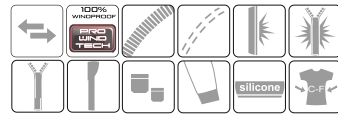

23V145.1

Black



23V145.3

Red / Black / White



24V145.40

Navy / White



23V145.2

Black / Blue



23V145.7

Olive Green

PREMIUM PANTS
UNISEX

Pro-wind-tech fabric:
50% Polyester, 35% Nylon, 15% Spandex
Size: XS, S, M, L, XL, XXL, 3XL

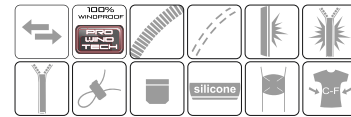

23V146.1

Black



23V146.4

Navy



23V146.7

Olive Green



23V147.1

Full Zip - Black

PREMIUM VEST
UNISEX

Pro-wind-tech fabric: 50% Polyester,
35% Nylon, 15% Spandex
Size: XS, S, M, L, XL, XXL, 3XL



23V148.3

Red / Black / White



23V148.1

Black





KARINA JACKET
WOMAN



Wind Protection Fabric:
60% Polyester bamboo,
25% Polyester, 15% Spandex
Size: XS, S, M, L, XL

24V120.21

Turquoise / Black



23V120.4

Navy



23V120.7

Olive Green



24V120.14

Lilac / Black

KARINA PANTS
WOMAN

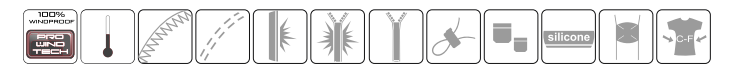

Wind Protection Fabric:
60% Polyester bamboo,
25% Polyester, 15% Spandex
Size: XS, S, M, L, XL

23V121.1

Black



23V121.4

Navy / Green



23V121.7

Olive Green

DAVOS XC TRAINING JACKET

UNISEX

Pro-wind-tech fabric: 50% Polyester,
35% Nylon, 15% Spandex

Size: XS, S, M, L, XL, XXL, 3XL



23V116.1

Black



23V116.12

Blue / Black



23V116.3

Dark Red / Black



23V116.8

Petrol / Black

DAVOS XC PANTS

UNISEX

Pro-wind-tech fabric:
50% Polyester, 35% Nylon, 15% Spandex

Size: XS, S, M, L, XL, XXL, 3XL

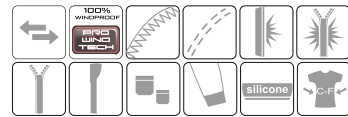

23V117.1

Black



CROSS XC JACKET UNISEX



Pro-wind-tech fabric:
95% Polyester, 5% Spandex
Size: XS, S, M, L, XL, XXL, 3XL

23V110.1

Black



23V110.2

Blue



23V110.3

Red



24V110.21

Turquoise / Black



CROSS XC VEST UNISEX

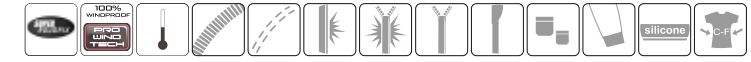

Pro-wind-tech fabric:
95% Polyester, 5% Spandex
Size: XS, S, M, L, XL, XXL, 3XL

21V113.1

Black



CROSS XC PANTS UNISEX



Pro-wind-tech fabric:
95% Polyester, 5% Spandex
Size: XS, S, M, L, XL, XXL, 3XL

21V112.1

Black



21V111.1

Black
With Removable Braces

FOCA JERSEY MAN

Fabric: 100% Polyester
Size: S, M, L, XL, XXL, 3XL



23V122.1

Dark Grey / Black



23V122.2

Dark Grey / Blue

FOCA JERSEY WOMAN

Fabric: 100% Polyester
Size: XS, S, M, L, XL



23V125.1

Dark Grey / Black

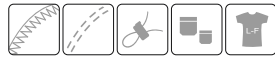

23V125.12

Dark Grey / Pink

FOCA JOGGER MAN

Fabric: 100% Polyester
Size: S, M, L, XL, XXL, 3XL



23V126.1

Dark Grey / Melange



FOCA JOGGER WOMAN

Fabric: 100% Polyester
Size: XS, S, M, L, XL



23V127.1

Dark Grey / Melange



EXPERT PRO PANTS MAN

Fabric: 100% Polyester
Size: S, M, L, XL, XXL, 3XL



24V135.1

Black

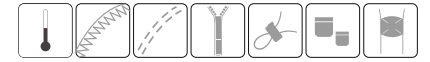

EXPERT PRO PANTS WOMAN

Fabric: 100% Polyester
Size: XS, S, M, L, XL



24V136.1

Black

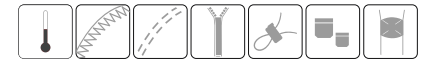

IRELAND WATERPROOF JACKET UNISEX

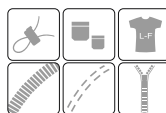

Fabric: 91% Polyester, 9% Spandex
Size: XS, S, M, L, XL, XXL, 3XL

21S25.1

Black



IRELAND WATERPROOF PANTS UNISEX



Fabric: 100% Polyester
Size: XS, S, M, L, XL, XXL, 3XL

20S26.1

Black



BREEZE WINDPROOF JACKET MAN

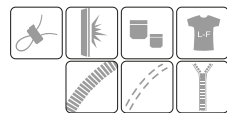

Fabric: 100% Nylon - 60 gr/m
Size: S, M, L, XL, XXL, 3XL

23S18.1

Black / Grey



BREEZE WINDPROOF JACKET WOMAN

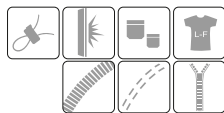

Fabric: 100% Nylon - 60 gr/m
Size: XS, S, M, L, XL

23SW18.2

Turquoise



23S18.2

Blue



23SW18.12

Lilac

ARTICO JACKET MAN

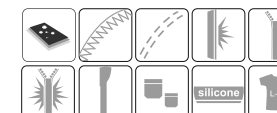

Fabric: 50% Nylon, 45% Polyester, 5% Elastan
Size: S, M, L, XL, XXL, 3XL

24V106.1

Black



ARTICO JACKET WOMAN

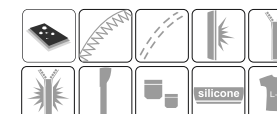

Fabric: 50% Nylon, 45% Polyester, 5% Elastan
Size: XS, S, M, L, XL

24V119.1

Black



ARTICO VEST MAN WITH REMOVABLE SLEEVES

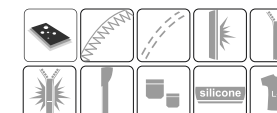

Fabric: 50% Nylon, 45% Polyester, 5% Elastan
Size: S, M, L, XL, XXL, 3XL

22V109.1

Black



ARTICO VEST WOMAN WITH REMOVABLE SLEEVES

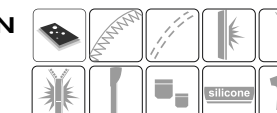

Fabric: 50% Nylon, 45% Polyester, 5% Elastan
Size: XS, S, M, L, XL

22V134.1

Black





SEEFELD JACKET
MAN

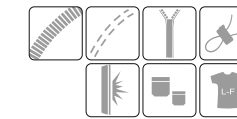

Fabric: 100% Nylon
Size: S, M, L, XL, XXL, 3XL

24V128.1
Black



24V128.4
Navy

LEVI JACKET
WOMAN

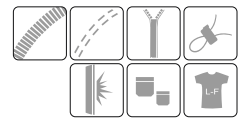

Fabric: 100% Nylon
Size: XS, S, M, L, XL

24V129.14
Old Rose



24V129.4
Navy

ECO BOMBER
MAN



Fabric: 50% Polyester, 50% Nylon
Size: S, M, L, XL, XXL, 3XL

21C30.1
Black



ECO BOMBER
WOMAN



Fabric: 50% Polyester, 50% Nylon
Woman Size: XS, S, M, L, XL

21C31.1
Black



DAKOTA JACKET WATERPROOF**Fabric:** 50% Polyester, 50% Nylon**Colour:** Black**Man Size:** S, M, L, XL, XXL, 3XL**Woman Size:** XS, S, M, L, XL

24V130.1

MAN



24V131.1

WOMAN

**DAKOTA PANTS****Fabric:** 50% Polyester, 50% Nylon**Colour:** Black**Man Size:** S, M, L, XL, XXL, 3XL**Woman Size:** XS, S, M, L, XL

24V132.1

MAN



24V133.1

WOMAN



CROSS XC JACKET KID UNISEX

Fabric: 87% Polyester,
10% Polyurethane, 3% Spandex
Size: J130, J140, J150

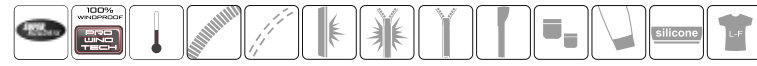

23V110.2J

Blue



23V110.3J

Red

CROSS XC VEST KID UNISEX

Fabric: 87% Polyester,
10% Polyurethane, 3% Spandex
Size: J130, J140, J150

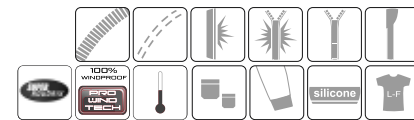

21V113.1J

Black



CROSS XC PANTS KID UNISEX

Fabric: 87% Polyester,
10% Polyurethane, 3% Spandex
Size: J130, J140, J150

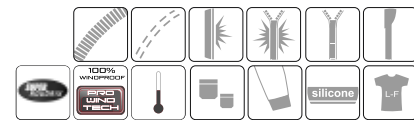

21V111.1J

Black
With Removable Braces



TORNADO TWO PIECES SUIT KID UNISEX

Fabric: 82% Polyester, 18% Spandex
Size: J130, J140, J150

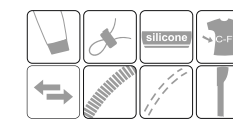

23V118.20J

Blue / White



SEEFELD JACKET KID UNISEX

Fabric: 100% Nylon
Size: J130, J140, J150

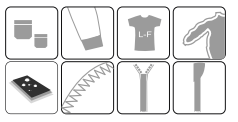

24V128.J

Black



TENERO UNDERWEAR KID UNISEX

Fabric: 88% Polyester, 12% Spandex
Size: J130, J140, J150



21U133.1J

Dark Grey



21U134.1J

Dark Grey





FIOCCO TOP

Fabric: 88% Polyester, 12% Elastan
Man Size: S, M-L, XL-XXL
Woman Size: XS-S, M-L

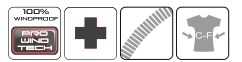

24U100.1

MAN - Blue

24U102.1

WOMAN - Old White



FIOCCO PANTS

Fabric: 88% Polyester, 12% Elastan
Man Size: S, M-L, XL-XXL
Woman Size: XS-S, M-L



24U101.1

MAN - Blue

24U103.1

WOMAN - Dark Grey



TENERO SHIRT

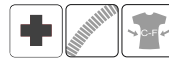

Fabric: 88% Polyester, 12% Elastan

Man Size: S, M-L, XL-XXL **Woman Size:** XS-S, M-L

21U133.1

MAN - Dark Grey

21U131.1

WOMAN - Dark Grey



TENERO PANTS



Fabric: 88% Polyester, 12% Elastan

Man Size: S, M-L, XL-XXL **Woman Size:** XS-S, M-L

21U134.1

MAN - Dark Grey

21U132.1

WOMAN - Dark Grey



TENERO BOXER

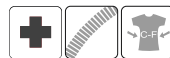

Pro-wind-tech fabric: 88% Polyester, 12% Elastan

Man Size: M-L, XL-XXL **Woman Size:** XS-S, M-L

21U107.1

MAN - Dark Grey



21U106.1

WOMAN - Dark Grey



NORDIC STEP SOCKS

Achilles Tendon Pad / Instep Pad / Footstep Protector

Fabric: 40% Cotton, 40% Polyester, 15% Lycra elastic, 5% Nylon

Colour: Dark Grey / Blue

Size: 35-38, 39-42, 43-46



6U21.1

LONG

6U20.1

REGULAR



JULIER SHIRT



Pro-wind-tech fabric: 88% Polyester, 12% Elastan

Man Size: S, M, L, XL, XXL, 3XL

Woman Size: XS, S, M, L, XL

21U121.1

MAN - Dark Grey / Black

21U123.1

WOMAN - Dark Grey / Black



JULIER PANTS



Pro-wind-tech fabric: 88% Polyester, 12% Elastan

Man Size: S, M, L, XL, XXL, 3XL

Woman Size: XS, S, M, L, XL

21U122.1

MAN - Dark Grey / Black

21U124.1

WOMAN - Dark Grey / Black



GLOVES



COLD PRO

Size: XXS, XS, S, M, L, XL, XXL

Fabric: 50% Polyester, 35% Polyurethane, 15% Nylon
Windproof with high breathable Pro Wind Tech membrane

HEAT	●●●●○
BREATH	●●○○○
RACING	●●●●●
WATERPROOF	●●●●○
WINDPROOF	●●●●●

24G05.1

Black



24G05.S

Black / Red



24G05.N

Black / Red



FOCUS

Size: XXS, XS, S, M, L, XL, XXL
Fabric: 45% Nylon, 25% Polyester, 25% Polyurethane, 5% Elastane
Windproof with high breathable Pro Wind Tech membrane

HEAT ●●●○○
BREATH ●●●●○
RACING ●●●●●
WATERPROOF ●●○○○
WINDPROOF ●●●●○

FOCUS KANGAROO

Size: XXS, XS, S, M, L, XL, XXL
Fabric: 100% Synthetic / 100% Kangaroo leather
Windproof with high breathable Pro Wind Tech membrane

HEAT ●●●○○
BREATH ●●●○○
RACING ●●●●●
WATERPROOF ●●○○○
WINDPROOF ●●●●○

21G07.1

Black



21G07.10

Black / Kangaroo



21G07.2

Black / Blue



RACE

Size: XXS, XS, S, M, L, XL, XXL
Fabric: 45% Nylon, 25% Polyester, 25% Polyurethane, 5% Elastane
Windproof with high breathable Pro Wind Tech membrane; Bossed fabric on the palm

HEAT ●●●○○
BREATH ●●●●○
RACING ●●●●●
WATERPROOF ●●○○○
WINDPROOF ●●●●○

24G08.2

Royal / Black



24G08.1

Black



ELITE

Size: XXS, XS, S, M, L, XL, XXL
Fabric: 45% Nylon, 25% Polyester, 25% Polyurethane, 5% Elastane

HEAT ●●●○○
BREATH ●●●●○
RACING ●●●●●
WATERPROOF ●●○○○
WINDPROOF ●●●○○

21G04.1

Black / Blue



GLACIER

Size: XXS, XS, S, M, L, XL, XXL

Fabric: 50% Polyester,
35% Polyurethane, 15% Nylon
Made of windproof
and waterproof materials

HEAT ●●●●●
BREATH ●●●●○
RACING ●●○○○
WATERPROOF ●●●●○
WINDPROOF ●●●●●

22G06.1

Black



ALASKA

Size: XXS, XS, S, M, L, XL, XXL

Fabric: 45% Sheep skin,
45% Polyester, 10% Nylon
Made of windproof
and waterproof materials

HEAT ●●●●●
BREATH ●●●●○
RACING ●●○○○
WATERPROOF ●●●●○
WINDPROOF ●●●●●

24G09.1

Black



BLIZZARD

Size: XXS, XS, S, M, L, XL, XXL

Fabric: 50% Polyester,
35% Polyurethane, 15% Nylon
Made of windproof
and waterproof materials

HEAT ●●●●●
BREATH ●●●●○
RACING ●●○○○
WATERPROOF ●●●●○
WINDPROOF ●●●●●

22G11.1

Black



DAVOS XC

Size: XXS, XS, S, M, L, XL, XXL

Size Junior: JM, JL

Fabric: 50% Polyester, 40% Synthetic leather, 10% Nylon
Made with high breathable Pro Wind Tech membrane

HEAT ●●●●○
BREATH ●●●●○
RACING ●●●○○
WATERPROOF ●●●○○
WINDPROOF ●●●●●

23G10.1

Black



23G10.1J

JUNIOR - Black



FINGER COVER FOR TOUCH SCREEN

Size: S, L

To be worn over the glove

9G03.1

Black



COVER

Size: S, M-L, XL

Fabric: 50% Polyester,
30% Polyurethane, 20% Nylon
Extra protection against wind and cold

8G12.1

Black



HATS

ST.MORITZ

22A12

Fabric: 80% Lambs Wool, 20% Nylon, Inside fleece band



VENTO

23A08

Fabric: Fabric: 80% Lambs Wool, 20% Nylon, Inside fleece band



TIROL

22A06

Fabric: 100% Acrylic, Inside fleece band



FIOCCO

22A13

Fabric: 50% Wool, 50% Acrylic, Inside fleece band



GOMS

22A11

Fabric: 80% Lambs Wool, 20% Nylon, Inside fleece band

104



107



110



101



PATRIOT

22A01

Fabric: 50% Wool, 50% Acrylic, Inside fleece band

SWI



NOR



USA



SWE



FRA



RACING

8A19

Fabric: 100% Polyester

101



105



107



110



108



BERGEN

8A22

Fabric: 100% Polyester

101



104



107



110



PREMIUM

22A02

Fabric: 92% Polyester, 8% Spandex

22A02S

115



108



104



114



106



101



TORNADO

22A16

Fabric: 92% Polyester, 8% Spandex

22A16S

115



108



104



114



106



101



TORNADO HEADBAND

Fabric: 92% Polyester, 8% Spandex

22A03

22A03.S

115



108



104



114



106



101



BANDANA

Fabric: 100% Polyester

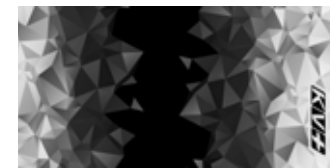

22A33.110

TORNADO

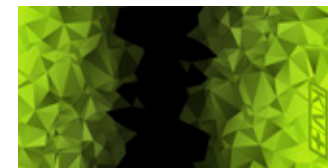

22A33.106

TORNADO



22A33.104

TORNADO



22A33.107

TORNADO



20A30.104

SKIER



20A30.105

SKIER



20A30.108

SKIER



20A30.110

SKIER



20A32.106

DEER WARM



20A32.110

DEER WARM



7A31.107

MULTISPORT



7A31.110

MULTISPORT



7A30.110

CAMPRA



20A31.105

LAPLAND

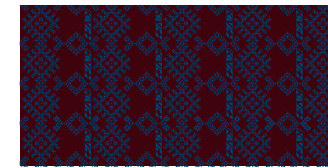

20A31.106

LAPLAND

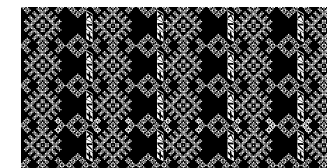

20A31.110

LAPLAND



KV+ CAP

24U152PR

Embroidered logo



WINTER 2023/24



KVplus SA
6715 Dongio
SWITZERLAND
tel: +41(0) 918722616
fax: +41(0) 918722008
mail: info@kv2.ch
WWW.KVPLUS.COM



WWW.KVPLUS.COM